

## Lifting capacity

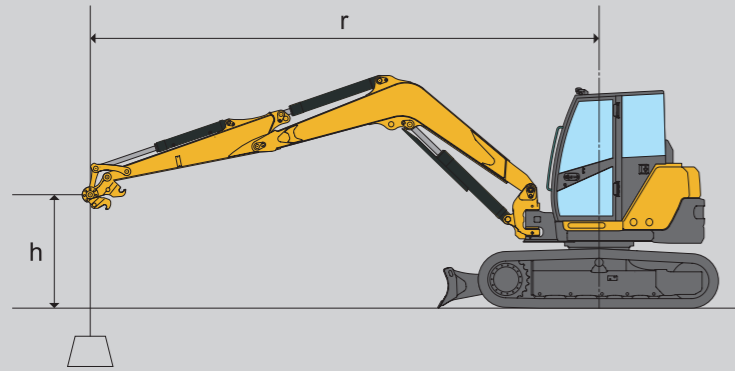

**Never allow total bucket weight to exceed excavator lift capacity.**

Note where applicable specifications conform to ISO standards.  
 Loads shown in table include weight of standard bucket (430 lbs. [195kg])  
 Weight of all lifting devices and attachment must be deducted to determine load can that be lifted.  
 Lift point is bucket hinge point with bucket fully curved.  
 Specifications subject to change without notice.

### Model ViO80-1 excavator quick coupler spec.

\*Rated hydraulic lift capacity.

LIFT POINT HEIGHT h : mm (in)	r : LIFT RADIUS mm (in)											
	RATED LIFT CAPACITY OVER END BLADE DOWN : kg (lbs)				RATED LIFT CAPACITY OVER END BLADE UP : kg (lbs)				RATED LIFT CAPACITY OVER SIDE BLADE UP : kg (lbs)			
	MAX	5000 (196.9)	4000 (157.1)	3000 (118.1)	MAX	5000 (196.9)	4000 (157.1)	3000 (118.1)	MAX	5000 (196.9)	4000 (157.1)	3000 (118.1)
5000 (196.9)	*1780 (3880)		*1730 (3814)		*1720 (3792)		*1680 (3704)		1340 (2854)		*1720 (3792)	
4000 (157.5)	*1680 (3680)	*1660 (3550)	*1730 (3814)		1190 (2623)	1340 (2954)	*1660 (3680)		1130 (2481)	1230 (2712)	*1710 (3770)	
3000 (118.1)	*1700 (3748)	*1750 (3858)	*2040 (4486)	*2580 (5710)	1020 (2240)	1310 (2888)	*1980 (4365)	*2530 (5578)	950 (2094)	1210 (2668)	*1990 (4387)	*2620 (5777)
2000 (78.7)	*1640 (3316)	*1910 (4211)	*2380 (5260)	*3240 (7144)	920 (2028)	1240 (2734)	1730 (3814)	*2920 (6438)	850 (1896)	1150 (2535)	1640 (3616)	2270 (5005)
1000 (39.4)	*1650 (3338)	*2050 (4520)	*2700 (5953)	*3580 (7915)	900 (1984)	1180 (2601)	1650 (3638)	2170 (4784)	850 (1896)	1120 (2480)	1540 (3395)	2030 (4476)
0 (Ground)	*1650 (3338)	*2070 (4554)	*2770 (6107)	*3770 (8312)	930 (2050)	1160 (2557)	1000 (3528)	2310 (5093)	880 (1940)	1070 (2350)	1520 (3351)	2150 (4740)
-1000 (-39.4)	*1620 (3572)	*1950 (4299)	*2580 (5710)	*3550 (7827)	1020 (2240)	1150 (2535)	1580 (3483)	2420 (5336)	970 (2138)	1080 (2381)	1490 (3285)	2220 (4895)
-2000 (-78.7)	*1460 (3219)		*2150 (4740)	*2930 (6460)	1220 (2690)		1630 (3594)	2500 (5512)	1190 (2523)		1550 (3417)	2350 (5181)

## Standard equipment

- Blade
- Boom swing function
- Rubber or Steel tracks
- Radio antenna and connection harness
- Back mirror / Side mirror
- ROPS / OPG Cabin
- Windshield washer
- Air conditioner
- Defroster
- LCD monitor
- Joystick pilot controls
- Arm rests (adjustable)
- Suspension and reclining seat
- Seat belt
- Proportional P.T.O mode
- Travel automatic dual speed
- Auto deceleration
- Eco mode
- Engine stop switch
- External power socket (12V)
- Cup holder
- Floor mats
- Evacuation hammer
- Ash tray

Please note that the standard equipment may vary from this list. Consult your Yanmar dealer for confirmation

## YANMAR CONSTRUCTION EQUIPMENT CO.,LTD.

OVERSEAS SALES DEPT.  
 MARKETING & SALES DEPT.

1717-1 Kumano, Chikugo, Fukuoka 833-0055, JAPAN  
 TEL +81-942-53-5465 FAX +81-942-53-5132

yanmar.com

All data subject to change without notice.



**YANMAR**

TRUE ZERO TAIL SWING MIDI EXCAVATOR

# ViO80-1

[Gross] 40.7kW



**NEW** POWER.

# ViO80-1

a best partner for you.



Clean diesel engine



True zero tail swing



Spacious cabin



Operation control



Quick coupler (Option)



Safety



Easy Maintenance

ViO, the next generation of small excavators, is a step ahead in every way, including ease of operation and maintenance, durability and the work performance you've been asking for, including Yanmar's original True Zero Tail Swing. The wide cabin interior and low noise are among a host of comfort factors. ViO is the perfect solution to help you work efficiently.

TRUE ZERO TAIL SWING  
MIDI EXCAVATOR

**ViO80-1**

# Advanced power that's good for the environment and saves fuel.

## An engine to meet tough emissions regulations.

ViO comes with Yanmar's TNV direct injection diesel engine, designed for clean emissions and powerful output. With an improved fuel injection system and other enhancements, the engine meets EPA (Environmental Protection Agency) Tier 4

Interim emissions regulations. With exceptionally low noise, the engine is easy on both people and the environment.



# CLEAN DIESEL ENGINE

**4TNV98** **40.7kW** / 2000rpm  
EPA Interim Tier 4

## Electronically controlled EGR\* system reduces air-polluting nitrogen oxides (NOx).

This system mixes a portion of the exhaust gases and with intake air to lower the concentration of oxygen in air intake.

That drops the combustion temperature, limits NOx emissions and boosts fuel efficiency. \*EGR : Exhaust Gas Recirculation

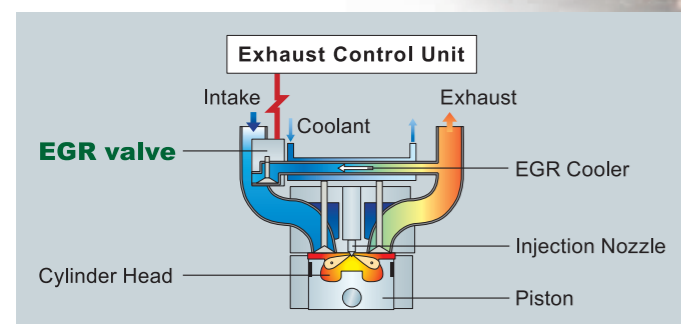

## Fuel efficiency.

Fuel efficiency has improved due to the excellently matched hydraulic system combined with the features of Eco mode and Auto deceleration, making it them the most fuel efficient excavator in their class.

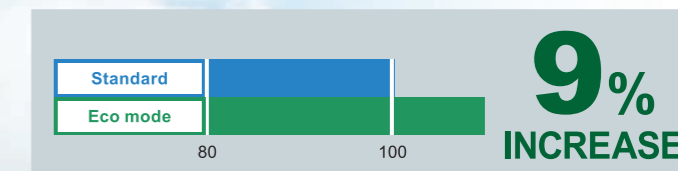

## Eco mode.

Switching to this controls the engine speed for efficiency and greatly reduces fuel consumption.

## Auto deceleration.

Switching the operating levers to neutral automatically drops the engine rpm and reduces on both fuel consumption and noise.

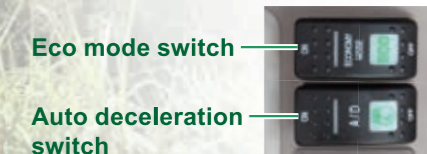

Advanced functions give you the efficiency you've been waiting for.

# YANMAR'S ORIGINAL TRUE ZERO TAIL SWING

Work efficiently, without worrying about tail swing — the body will stay within the machine width. This helps reduce operator fatigue and cut work time.



Blade Width  
**2,260 mm (7'5")**

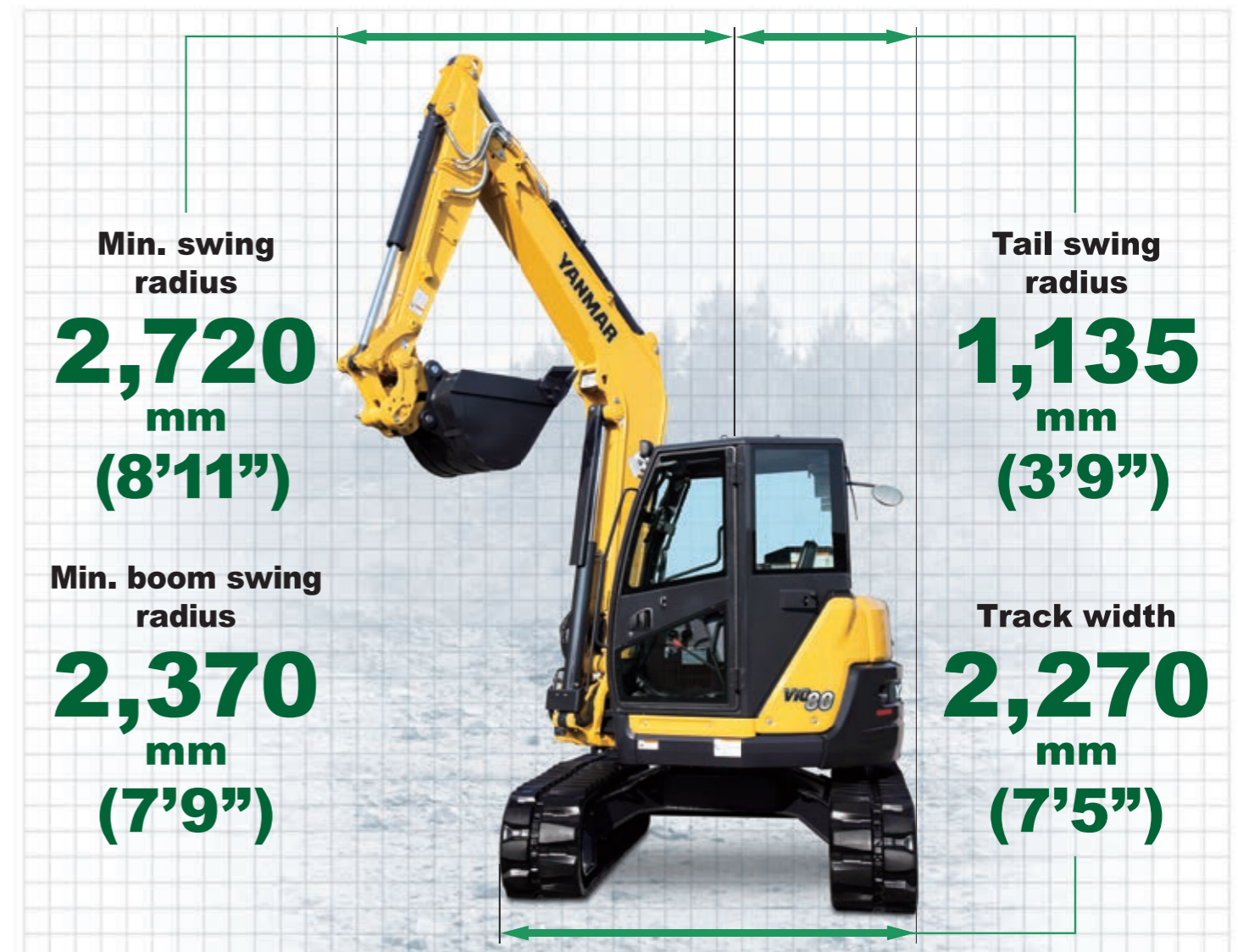

Even the boom swing bracket stays within the machine width.

### Electronically controlled engine and new hydraulic system for more work with less fuel.

The ViO80-1's electronic control of engine speed and torque synergizes with the high efficiency hydraulic system to yield fast activation. This lets you do more work while greatly cutting fuel consumption.

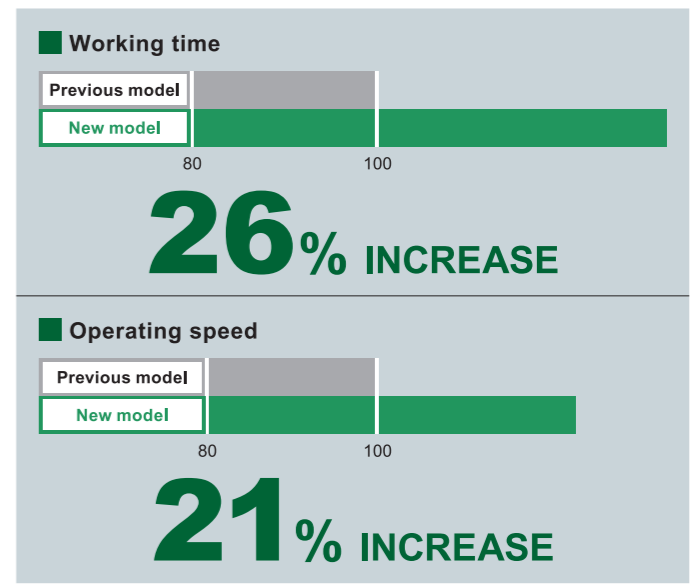

Spacious cabin space for operator comfort.

# SPACIOUS CABIN



**Large, comfortable cabin provides plenty of operating space.**

The ViO80-1 features a spacious cabin that offers improved comfort for the operator. Operators have great visibility through a wide front glass that slides up and down for easy communication with people outside. There is plenty of leg room, and its wide door provides easy entry.

■ Cab width

**800 mm**  
(2'7")



■ Entrance

**730 mm**  
(2'5")



■ Leg room

**700 mm**  
(2'4")

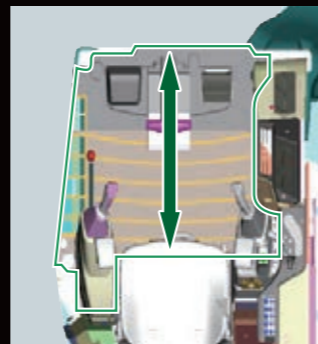

## AIR-CONDITIONER

### Multi-functional air conditioner.

The ViO80-1 is equipped with a powerful air conditioner that features defroster, Air Recirculation and Outside Air modes to provide a pleasant work atmosphere all year round.

### Air Recirculation and Outside Air modes.



**A / C Using outside air + defroster function enable comfort on the job.**



A/C Control Panel

Defroster



## LOW-NOISE CABIN

**Quiet cabin environment for reduced operator stress.**

Designed using sturdy, sound-reducing, advanced anti-vibration technology, the ViO80-1 provides the quietest operation environment yet. The noise level inside the cab is just 72dB(A), greatly reducing fatigue over long hours of work.

**72**  
dB(A)

**Liquid-filled cab anti-vibration mount for excellent sound blocking and comfortable ride.**

The five-point support provides efficient absorption of heavy vibration. This diminishes cabin noise and operator stress on the job.

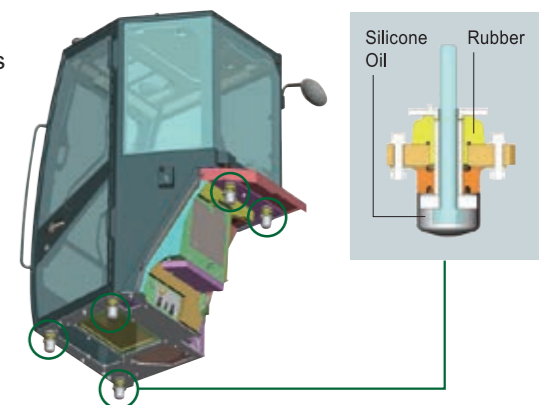

Operate comfortably  
in the position that suits you best.

# COMFORTABLE OPERATION

## 1 Advanced product support with new operation control system.

The new LCD action monitor provides various information, including machine service life and servicing alerts for smart machine maintenance.

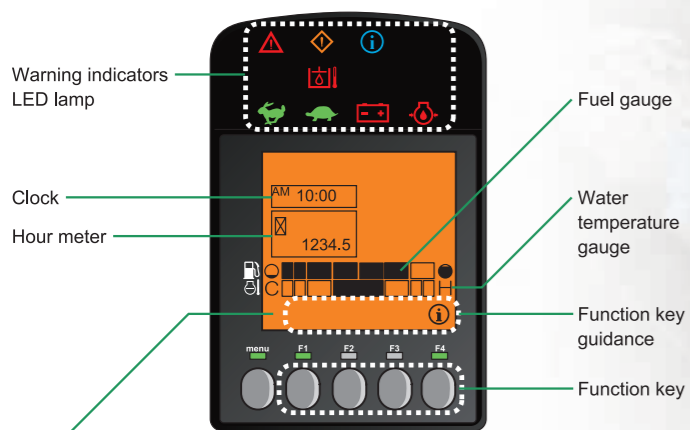

### LCD monitor display examples

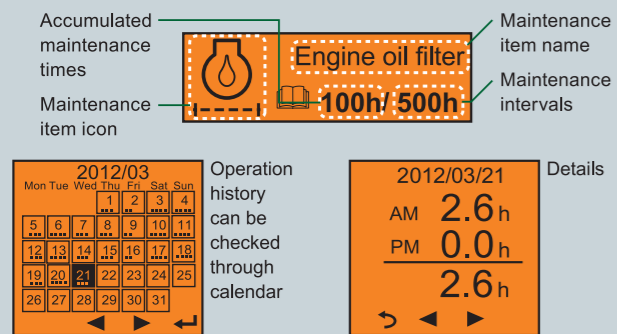

## Yanmar Smart Assist can be set as on option.

The system performs centralized control of machine operation information, maintenance support information, and machine position information, aiming at providing a speedy and highly efficient service and enhancing security.

## 2 Wrist control levers + adjustable arm rests.

Wrist control lever are easy to grasp, and arm rests can be repositioned to meet the operator's preferences and work posture, reducing fatigue even after long hours of operation.

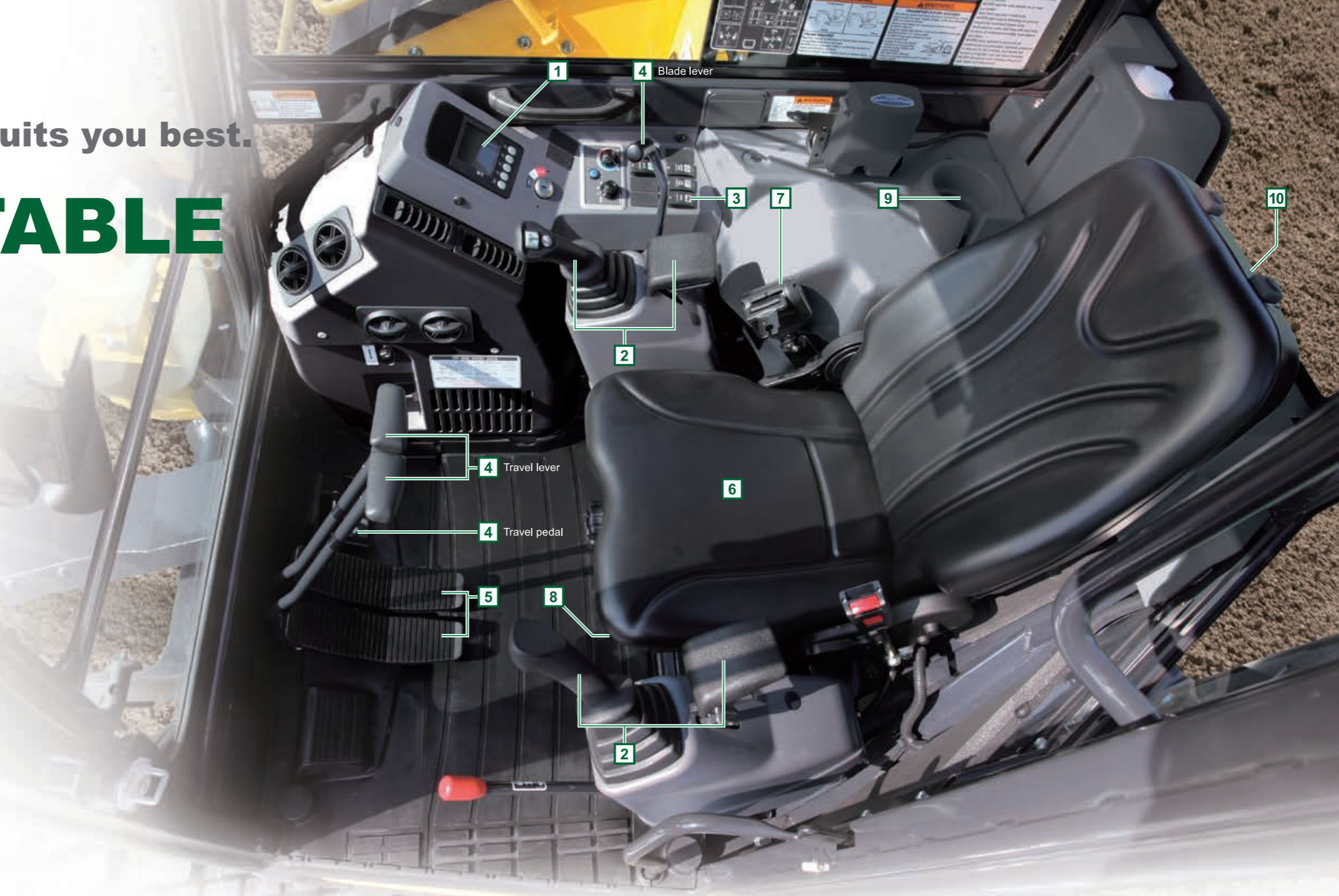

**3 Automatic two-speed travel system switches from high speed to low when handling heavy loads and returns to high speed when load lightens.**

**4 Blade lever, travel lever and travel pedal are all hydraulic controlled to provide light and smooth operation.**

**5 Large travel pedals are easy to press.**

**6 Double-slide seat mechanism for relaxed operation.**

Not just the seat, but the operating levers and seat can slide back and forth simultaneously, enabling optimal lever position and operating posture for the operator's body type.

**7 Retracting seat belt is easy to buck and stays out of the way when not in use.**



(The ROPS protective structure assumes the operator is wearing a seatbelt)



External power socket Cup holder Storage space



Evacuation hammer Engine stop switch Radio antenna + Connection harness

### Multi control pattern.

Numerous improvements to increase work efficiency under all types of conditions.

# FAST & EASY QUICK COUPLER (Option)



## Hydraulic quick coupler allows for quick and dirt free bucket and removal.

The quick coupler makes the once troublesome task of changing buckets fast and easy without even getting your hands dirty. It's all performed by switch operation while you remain seated, except for fitting and removal of the safety lock pin. You can also use attachments made by other companies, thereby reducing storage costs and saving space.

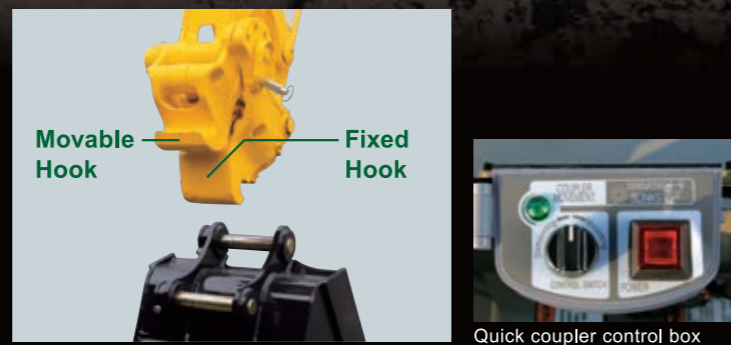

### Bucket Removal

- Place the bucket on the ground
- Pull out the safety lock pin
- Turn the switch to Dismounting.
- Raise the arm to detach.

### Bucket Attachment

- Apply the fixed hook
- Make the bucket level.
- Turn the switch to Mounting
- Insert the safety lock pin and fasten.

Tough protective structure lets you work with greater confidence.

## ISO - conforming cabin with enhanced sturdiness for safety and dependability.

The cabin's use of extra-strength, extra-sturdy ROPS protects the operator in the event of a roll-over. It also conforms to the OPG Level 1 standard for structures protecting the operator from falling objects. This sturdy cabin lets you work in comfort and confidence.

**ROPS**  
Roll over protective structure  
(ISO12117-2)

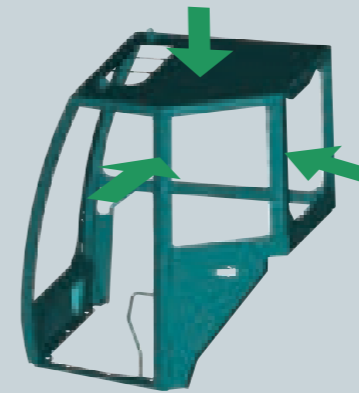

**OPG**  
Operator protective guards  
(ISO10262 / Level 1)

## Front guard / head guard brackets are standard equipment.

Users can easily attach a front guard and head guard by bolting them on, thus increasing protection of the operator.



## Lock lever includes engine neutral start mechanism to prevent danger of accidental operation.

The engine will not start unless the lock lever is completely locked, which prevents equipment from moving suddenly if the lever is accidentally operated when the engine is started.

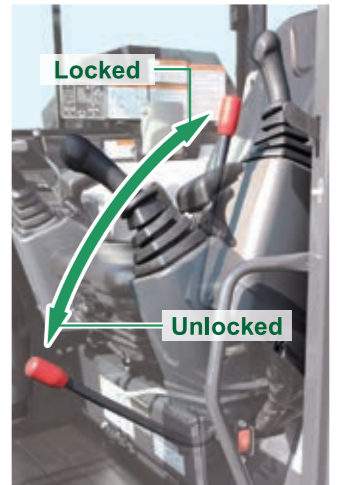

## The travelling alarm warns others the machine is moving.

Standard back and side mirrors let operator check for safety around and behind machine and keep others safe.



## Track frame provides handy anchor holes for secure machine transportation.



# Easy day-to-day maintenance. Greater durability.

## Simple maintenance structure for fast and easy access wherever it's needed.

Covers open easily without any special tools, enabling fast and smooth checks and minimizing maintenance and cleaning times.

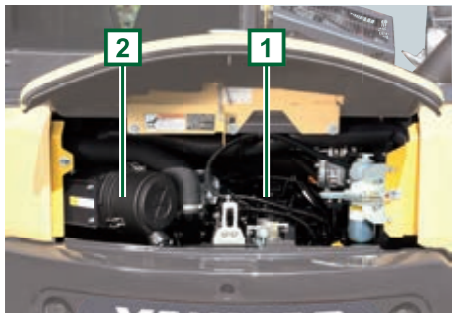
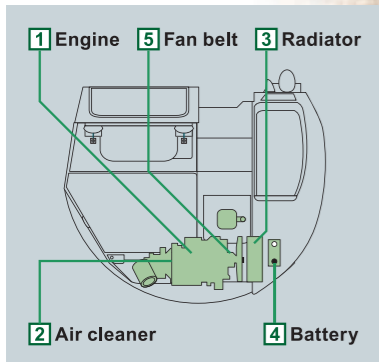

The wide-opening rear hood opens without special tools for easy checks and maintenance of the engine area and air cleaner.

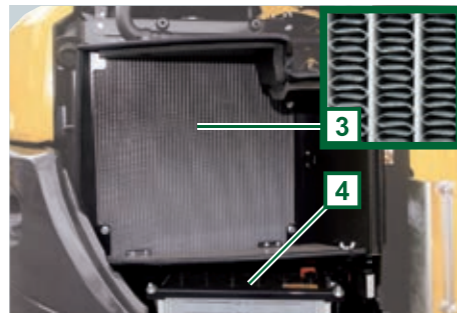

The right hood similarly opens wide and without tools to facilitate battery checks. It's also easy to clean the radiator, which is a wave fin style that resists clogging.

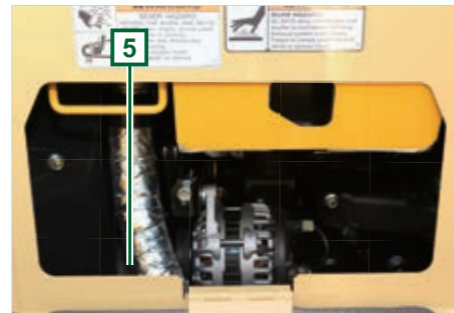

Easy to adjust the fan belt and air conditioning belt.

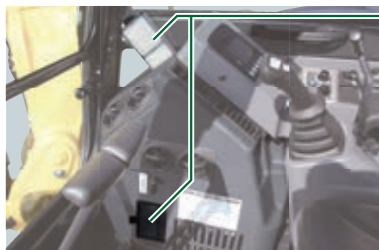

Air conditioning filters inside the cab removes easily without tools for easy cleaning and replacement.

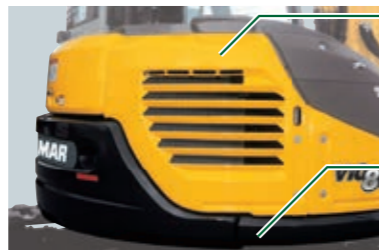

Iron plate hood is highly durable, makes damage repair easy.

Underside protector is thicker for greater strength.



Cab floor mats with high ends keep dust from getting under the mats and are easily washed with water.



The bottom of the fuel tank has a flange for easy cleaning.

Maintenance-free hydraulic oil-lubricated reduction gears in the Travel Motor.

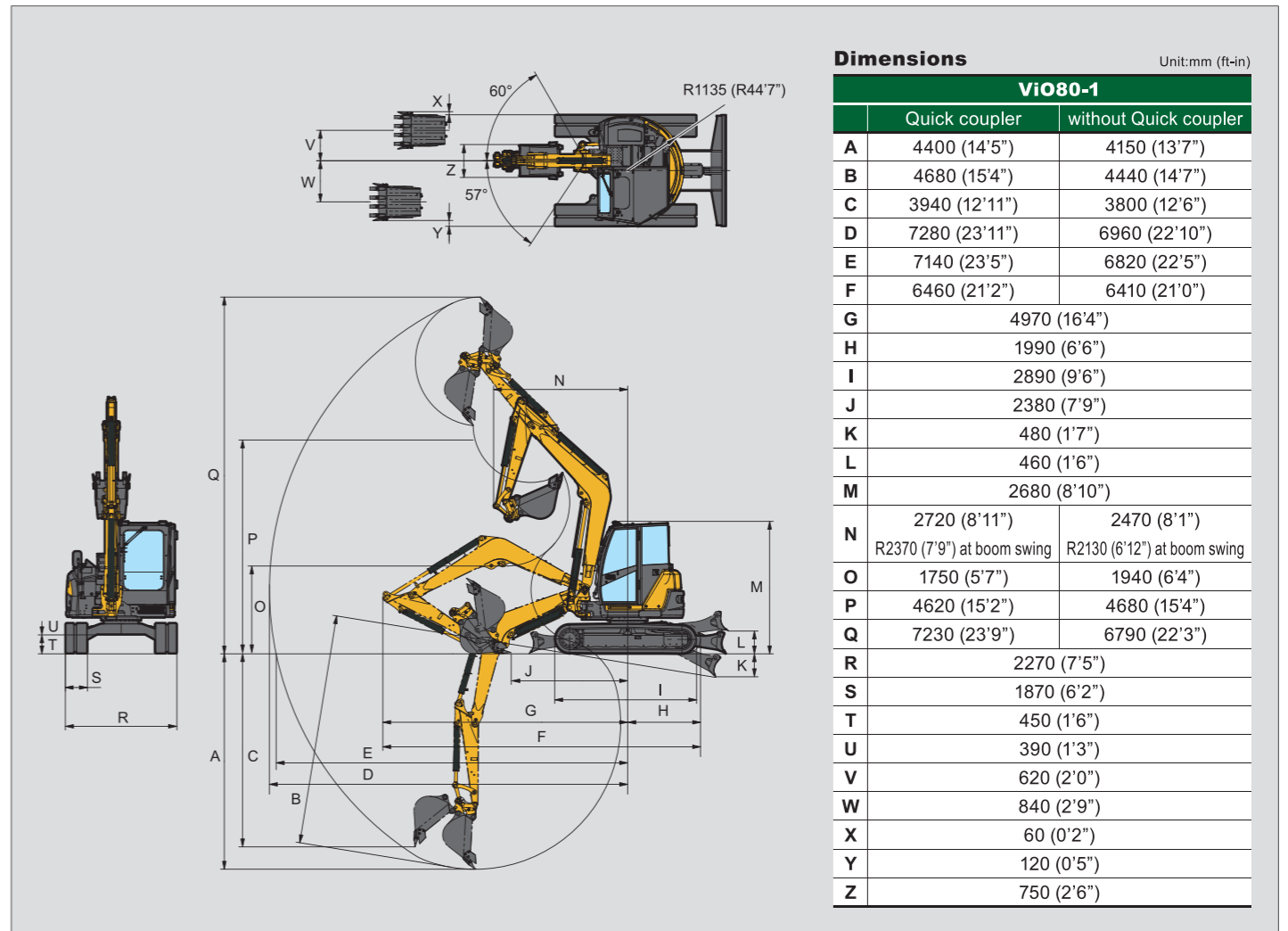

## Specifications

Model		ViO80-1				
Spec		Cab. rubber track		Cab. steel track		
Type		Quick coupler	without Quick coupler	Quick coupler	without Quick coupler	
<b>Operating weight</b>		kg (lbs)	8225 (18136)	8065 (17780)	8285 (18268)	8125 (17913)
<b>Engine</b>		Type	Vertical four cylinder water-cooled direct injection diesel engine			
		Model	YANMAR 4TNV98-ZWBV2			
		Rated output	kW (hp) / rpm			
		Maximum output at high idle speed	kW (hp) / rpm			
<b>Performance</b>		Bucket capacity (ISO heaped)	cu.m (cu.ft)			
		Max digging force, bucket / arm	50.4 (11330) / 37.2 (8683)	63.5 (14275) / 40.8 (9172)	50.4 (11330) / 37.2 (8683)	63.5 (14275) / 40.8 (9172)
		Traveling speed, high / low	4.5 (2.8) / 2.5 (1.6)		4.1 (2.6) / 2.3 (1.4)	
		Swing speed	RPM			
		Boom swing angle, (L / R)	degrees			
		Gradability	degrees			
<b>Ground contact pressure</b>		kPa (PSI)	35.8 (5.19)		36.2 (5.25)	
<b>Hydraulic system</b>		Pump capacity	L / min (GPM)			
		Main relief set pressure	MPa (PSI)			
<b>Blade dimensions</b>		Width	mm (ft-in)			
		Stroke, raise / lower from G.L.	460 (1'6") / 480 (1'7")		440 (1'5") / 500 (1'8")	
<b>Fuel tank capacity</b>		L (Gals)	115 (30.4)			

## Hydraulic PTO

Model		ViO80-1		
Specification		Output	L / min (GPM)	
		kPa (PSI)	1900RPM	1200RPM
<b>Combined flow, double actions</b>		25.5 (3698)	120 (31.7)	75 (19.8)